

HEWLETT-PACKARD JOURNAL

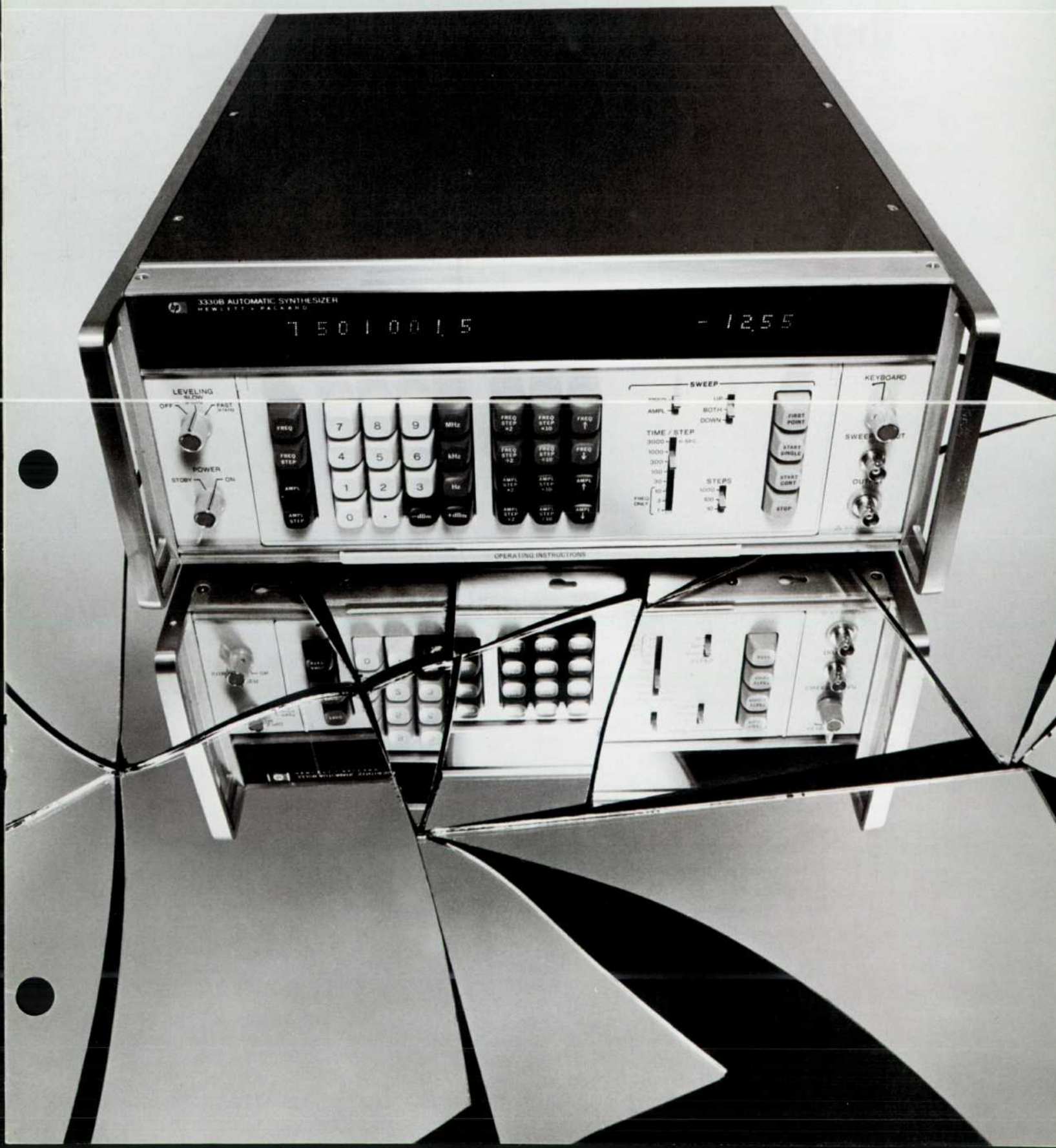

The Synthesized Test Oscillator— A New Signal Source for the 0.1 Hz-13 MHz Range

Programmability, high accuracy in frequency and level setting, waveform purity—these are some of the capabilities now being asked of wide-range signal sources. Meeting these needs requires something other than a traditional RC oscillator.

By Ronald K. Tuttle

WIDE-RANGE TEST OSCILLATORS—those that commonly work in a 10-Hz to 10-MHz range—are among the basic test instruments that electronic engineers rely on. These oscillators find widespread use as a source of test signals for determining the characteristics of amplifiers, filters, IF strips, networks, mixers, and components,—as a source of test signals for whole systems,—as a driver for ac bridges, vector voltmeters, and network analyzers,—as a calibrator for voltmeters, oscilloscopes, and receiver dials,—and as a source of signals in the audio, ultrasonic, video, and lower radio-frequency ranges, wherever they may be needed.

But times are changing, and with the times new measurement situations are arising, creating a demand for signal sources with more sophisticated capabilities. Mostly the need is for sources with greater stability and resolution, both in frequency and amplitude, as crowding of communications channels demands better control over frequency-sensitive devices. Concurrently there is a growing demand for programmability as more and more testing is turned over to automatic systems.

At the same time, to fulfill traditional laboratory uses for wide-range test oscillators, there can be no compromise with waveform purity. And, as always, cost is important.

Answering the Call

To meet these needs, two new test oscillators have been developed. Each has a frequency range extending from well below 1 Hz up to and beyond 10 MHz, 30% overranging extending the maximum frequency to 13 MHz.

Both of these instruments use frequency synthesis to gain the sought-for frequency stability and

stability. To keep costs down, 'indirect' synthesis is used but at the same time a purity of waveform some 20 dB better than that usually associated with indirect frequency synthesis is achieved.

One of the instruments has a new leveling circuit that realizes an accuracy of ± 0.05 dB in level setting. This instrument combines the accuracy of a calibrator with the flexibility of a test oscillator.

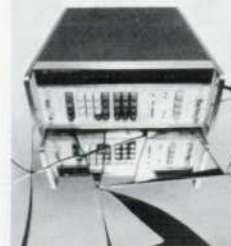

Cover: *This photo implies that combining the pieces of mirror would synthesize the image of HP's new Automatic Synthesizer. How HP's new 0.1 Hz - to -13 MHz signal sources synthesize frequencies by combining fractions and multiples of a quartz crystal frequency is described in two of the articles in this issue. The third article describes how new instructions for the HP 2100A Computers can be 'synthesized' using microprogramming.*

In this issue:

'The Synthesized Test Oscillator—A New Signal Source for the 0.1 Hz - 13 MHz Range,' by Ronald K. Tuttle . . . **page 2**

'The Incremental Sweep Generator—Point-by-Point Accuracy with Swept-Frequency Convenience,' by Charles A. Kingsford-Smith . . . **page 9**

'Microprogramming and Writable Control Store,' by Fred F. Coury . . . **page 16**

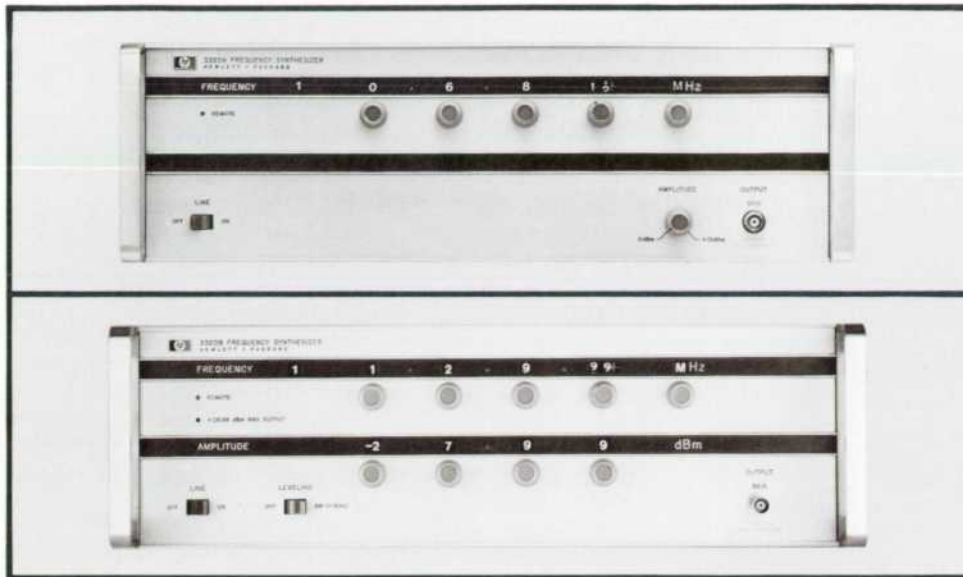

Fig. 1. Model 3320A Frequency Synthesizer has 3-digit resolution on each of five decade ranges but it has 5-digit accuracy. Vernier control, when switched in, gives 5-digit resolution on each range in trade-off with accuracy.

Fig. 2. Model 3320B Frequency Synthesizer gives high-resolution control of output level as well as synthesizer accuracy and frequency stability. Frequency range is 0.01 Hz to 13 MHz.

When provided with appropriate options, both instruments can be programmed through BCD inputs and one can also be programmed through a 'party-line' bus, an arrangement that greatly simplifies use of the instrument in automatic systems. The programming options are field-installable so programmability can be added any time it is desired to automate a measurement set-up.

The Synthesized Sine-wave Oscillator

The lower-priced instrument of this pair is the Model 3320A Frequency Synthesizer (Fig. 1). It performs the functions of the familiar wideband test oscillator where amplitude control is not critical, but it performs these functions with significantly greater precision in frequency.

Basically, this instrument has 3-digit resolution (0.1% of range) in frequency settability. However frequency accuracy, which is 0.001% of setting, is equivalent to 5 digits. For example, the user can select an output frequency of 986 Hz with assurance that the instrument really produces 986.00 Hz within ± 0.01 Hz.

This accuracy is maintained throughout an ambient temperature range of 0°C to 55°C. The basic frequency reference is an ambient-temperature quartz crystal that remains within ± 10 ppm of its original setting per year. An optional crystal oven gives an aging rate of ± 1 part in 10^7 per month. The instrument can also be slaved to an external frequency standard.

A new combination of synthesis techniques makes it possible to obtain the 3-digit resolution and 0.001% accuracy on each of five frequency ranges, which extend from 1 kHz full scale to 10

MHz full scale in decade steps or, with options, from 10 Hz full scale to 10 MHz in seven ranges. An output frequency of 500 Hz, for example, will have the same percentage accuracy as an output of 5.00 MHz.

Greater frequency resolution can be obtained in a trade-off with accuracy. A 10-turn VERNIER control, when switched in, adds two digits to give a total of 5-digit resolution. Accuracy is then 0.01% of range.

The new Synthesizer generates sine waves with even higher purity than that usually obtained from RC oscillators. Harmonic distortion in the output waveform is below -60 dB (0.1%) from 5 Hz to 100 kHz at maximum output. Up to 1 MHz, distortion is less than -50 dB and at 13 MHz, it is still less than -40 dB (1%). Any non-harmonically related components in the output signal are each less than 0.1% of the output.

Maximum output of the 3320A is 13 dBm (1 volt into a 50-ohm load) and the output level stays within ± 2 dB across the entire frequency range. The output is reducible to 0 dBm (0.225V/50 Ω) with a $\frac{3}{4}$ -turn front-panel potentiometer.

Synthesized Test Oscillator

For high precision in output level setting as well as in frequency setting, the Model 3320B Frequency Synthesizer (Fig. 2) uses a precision leveling circuit for its output. The instrument has a direct-reading, four-digit amplitude control that enables selection of the output level with 0.01-dB resolution. It also has a much wider range of control than the 3320A, from -69.99 dBm (80 μ V) to +26.99 dBm (5V/50 Ω , or a full $\frac{1}{2}$ watt).

The output level of the Model 3320B is established with much more accuracy, as well as much higher resolution, than that obtained with the usual meter-plus-attenuator arrangement. Accuracy of level setting is within ± 0.05 dB absolute (at 10 kHz), an accuracy comparable to that of ac calibrators. The instrument's frequency response is comparable: ± 0.05 dB all the way from 10 Hz to 13 MHz (Fig. 3).

As for frequency characteristics, the 3320B is identical to the 3320A. The two differ only in the way the output amplitude is controlled.

Party-line Programming

Of special importance to those concerned with repetitive or automatic tests, the Model 3320B Frequency Synthesizer (with options) can be programmed through a party-line bus. Programming is accomplished by sending 7-bit instructions sequentially to the instrument. Thus, only ten input lines (seven data lines plus 'remote enable,' 'response enable,' and 'data valid') are needed to control the instrument. Furthermore, it responds only to commands that directly follow an address that has been assigned to it so several instruments may be connected in parallel to the same programming lines. This arrangement greatly simplifies the hardware and software needed for automatic control.

Inside the 3320A/B Frequency Synthesizers

Now for a look behind the front panels. Unlike conventional indirect synthesizers that derive an output from the sum and difference frequencies of several phase-locked oscillators, the Models 3320A and 3320B Frequency Synthesizers have only one phase-locked oscillator. A divide-and-mix technique, similar to that used in the HP Model 203A Variable-Phase Function Generator¹, gives the instruments seven frequency ranges to maintain the same percentage frequency resolution over a wide range of frequencies.

The output signal originates in a voltage-tuned oscillator (VTO) slaved to a fixed, reference oscillator by way of divider circuits in a phase-lock loop (Fig. 4). The VTO operates at a frequency between 20.00 and 32.99 MHz which, when divided by a factor N , results in 10 kHz. This signal is compared in phase to a 10-kHz reference, divided down from a 20-MHz primary reference crystal oscillator, to derive a control signal for locking the VTO to the primary reference.

On the highest frequency range, the output frequency is derived by subtracting the 20-MHz reference from the VTO output. This gives outputs over a range of 0.00 to 12.99 MHz.

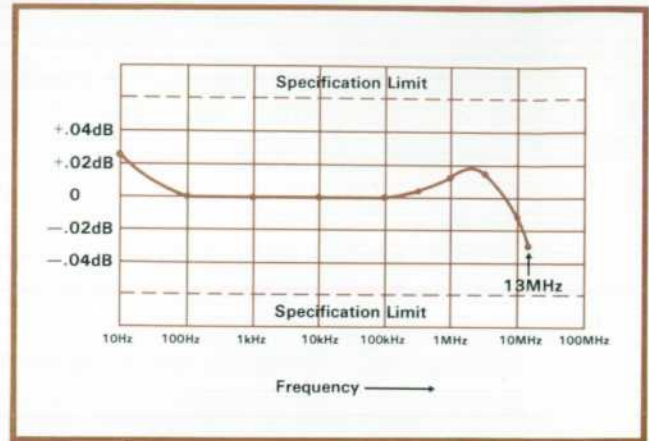

Fig. 3. Unusually flat frequency response of Model 3320B Frequency Synthesizer is made possible by new component and circuit developments.

On the next lower range, the VTO output frequency (f_t) is divided by 10 and then added to an 18-MHz constant, as shown in Fig. 5.

Algebraically, this is what happens. The phase locked VTO output (f_t) equals the crystal reference (f_r) plus an increment (Δf) that ultimately becomes the output frequency.

$$f_t = f_r + \Delta f$$

On division by 10 and addition to 18 MHz ($0.9f_r$):

$$\begin{aligned} 0.1f_t + 0.9f_r &= 0.1f_r + 0.1\Delta f + 0.9f_r \\ &= 1.0f_r + 0.1\Delta f \end{aligned}$$

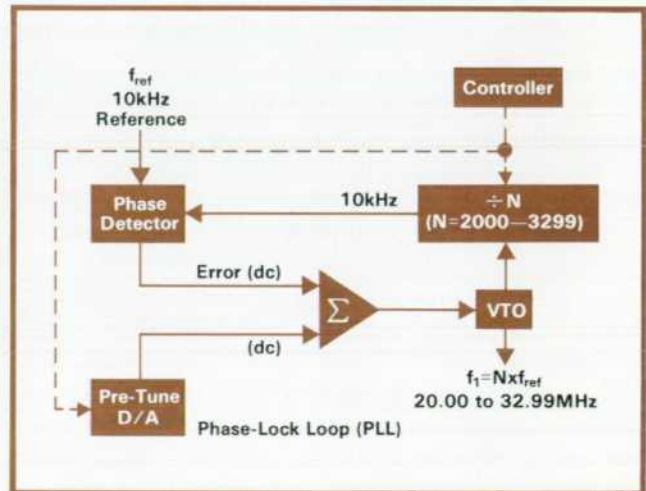

Fig. 4. Phase detector output adjusts voltage-tuned oscillator (VTO) to frequency that is N times 10-kHz reference frequency f_{ref} . In response to front-panel frequency controls, controller sets $\div N$ block, a preset digital counter, to count down VTO output cycles by factor of N . Controller also sets pre-tune digital-to-analog converter to produce dc that tunes VTO close to desired frequency, speeding up restabilization of phase-lock loop when large changes in frequency are made.

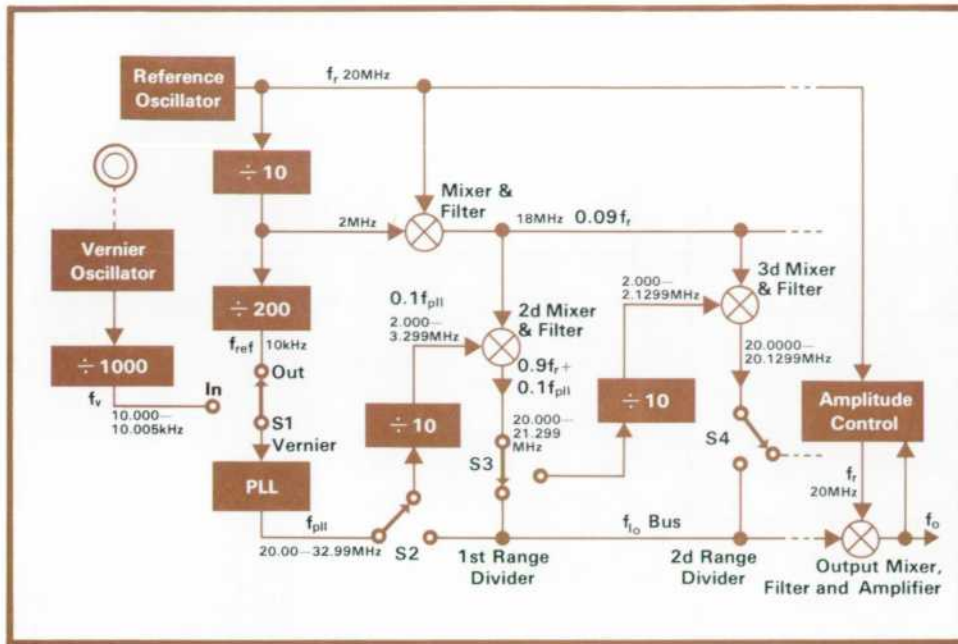

Fig. 5. Simplified block diagram of Models 3320A and 3320B frequency generating circuits shows first two of five divider circuits (seven optional) that reduce span of 'local-oscillator' frequency f_{lo} in decade steps. Switches S2 and S3 are set here to give output range of 0.000-1.299 MHz. To give finer resolution in frequency selection, switch S1 substitutes vernier signal f_v for 10-kHz reference f_{ref} .

In other words, the range divider restores the reference frequency portion to full value while dividing Δf by a factor of 10.

This process is repeated on the lower ranges, each range divider output serving as the input to the next. Each divides the output frequency by a factor of 10 and maintains three-digit resolution and full frequency stability in so doing.

An important by-product of this technique is that phase instability (phase noise) is also reduced by a factor of 10 each time the instrument is down-ranged (to a minimum of -75 dB, integrated, imposed by the 18-MHz 'constant'). Typical phase noise performance is shown in Fig. 6.

Vernier Frequency Control

To get fine-resolution adjustment of the output frequency, the VERNIER switch (S1 in Fig. 5) substitutes a frequency that is variable about 10 kHz for the fixed 10 kHz used as the reference in the phase-lock loop. The variable frequency is derived from a 10-MHz crystal oscillator that can be varactor-tuned over a narrow range of 0.05%, equivalent to one unit in the third frequency digit. This effectively gives two more digits of resolution in control of the Synthesizer's output frequency, or a resolution of 1 part in 10^6 when using the interpolating scale on the 5th digit indicator.

The 'vernier out' mode yields the better accuracy and stability since both inputs to the output mixer are then derived from a common source but stability of the 'vernier in' mode is also very good, as shown by the recording of Fig. 7.

Amplitude Control

Electronic control of the Synthesizers' output level can be readily effected by using a dc-controlled modulator to control the level of the 20-MHz reference signal (minor amplitude variations in the 'local oscillator' signal have no effect because this signal is large enough to saturate the output mixer). Since the reference is a fixed, high-frequency signal, harmonics that may be introduced by the modulator are easily removed before they reach the output. In the Model 3320A, front-panel control of the dc current into a modulator in the 20-MHz reference line controls the output over a 0 to +13 dBm range.

Precise control of the output level is achieved in the Model 3320B by use of a servo loop. High accuracy was made possible by a thin-film thermopile, developed for the HP Model 3480A Digital Voltmeter², which serves as the output level detector for the servo loop.

Over an amplitude range of 10 dB, the thermopile has a nearly ideal square-law response, and is thus an accurate indicator of the rms level of the signal in this amplitude range. To take advantage of this fact, the Model 3320B's attenuator is partitioned into a relay-controlled step attenuator, that has 10-dB steps, and an electronic attenuator that works over a continuous 10-dB range. This gives a 100-dB range of control in steps as small as 0.01 dB.

In the electronic attenuator, the 1, 0.1, and 0.01 dB digits selected by the front-panel controls are converted to a highly accurate dc reference voltage which is compared to the thermopile output (Fig. 8).

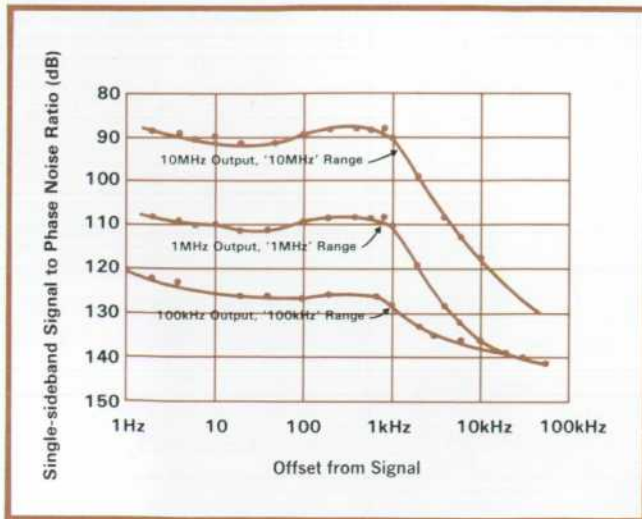

Fig. 6. Phase noise of Models 3320A/B Frequency Synthesizers in 1-Hz band referenced to output frequency. Phase noise reduces 20 dB each time instrument is down-ranged until limited by phase noise of 18-MHz 'constant' frequency.

The difference between the two is used as a correction voltage applied to the modulator to bring the Synthesizer output to the desired level.

Exponential Reference

Since the attenuator controls read in dB, the amplitude reference has to have the appropriate non-linear transfer function, which would be exponential in this case. To attain an exponential response, the converter uses the discharge characteristics of an RC circuit, timed by clock pulses according to the attenuation selected. Each clock pulse represents a 0.01-dB increment.

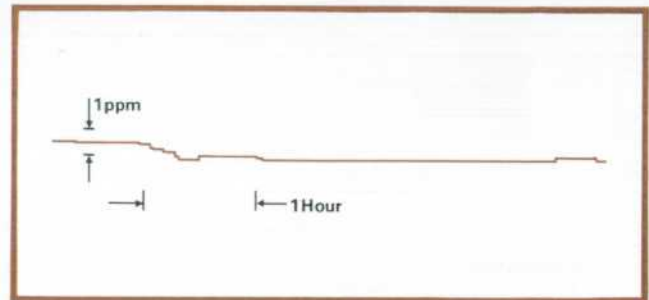

Fig. 7. Frequency stability typical of Models 3320A/B operating in 'vernier in' mode.

Circuit operation is as follows:

1. Initially, reference capacitor C_r charges to 10 volts.
2. Switch S10 opens and S11 closes, starting C_r discharge. The digital controller starts counting clock pulses.
3. When the count reaches the number equivalent to the desired attenuation, S11 opens and S12 closes, transferring the voltage on C_r to holding capacitor C_h .
4. S12 opens, S10 closes and the cycle repeats.

As a result, capacitor C_h holds a voltage that is exponentially related to the attenuation wanted. Since this is used in the feedback leg of the leveling loop, the leveling loop has an inverse, i.e. logarithmic, response.

The major source of error in this system is the stability of the RC time constant, and this was designed to provide excellent performance.

At output frequencies much below 10 Hz, the thermopile output would follow the waveform and

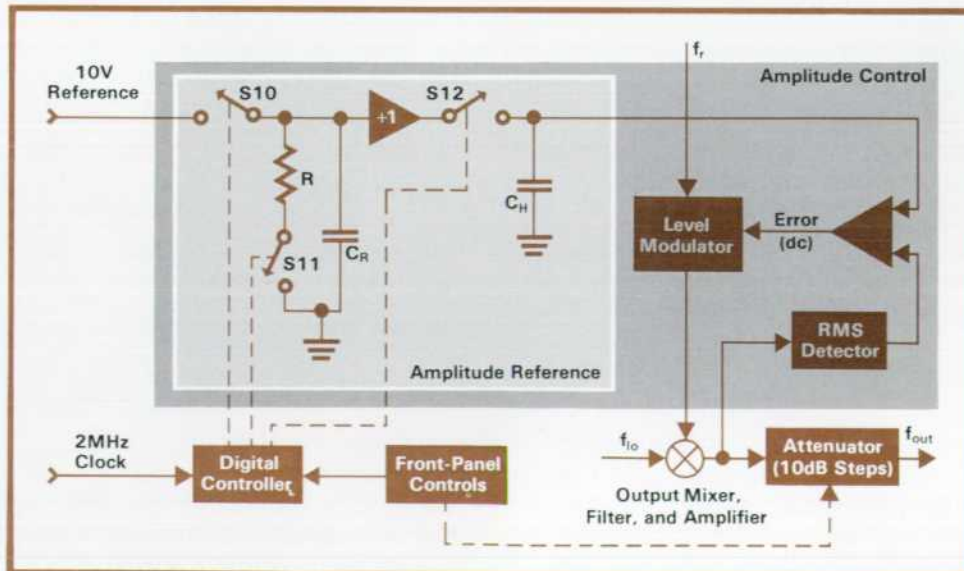

Fig. 8. Elements of Model 3320B amplitude control circuit. RMS detector (thermopile) senses output signal level ahead of step attenuator and produces proportional dc that is compared to reference dc. Any difference (error) modulates level of 20-MHz reference frequency f_r to bring mixer output to desired level. Reference dc establishes 1, 0.1, and 0.01 dB digits in output amplitude level. Step attenuator selects 10-dB digits.

the control system would then distort the waveform. For this reason, a front-panel leveling switch is provided for use at frequencies below 10 Hz. This switches the thermopile input from the output line

to the 20-MHz reference line. The amplitude control circuit then operates to maintain the 20-MHz signal at a constant level, giving a frequency response of ± 0.5 dB. (Text continued on next page.)

SPECIFICATIONS

HP Model 3320A/B Frequency Synthesizer

FREQUENCY RANGE: 0.01 Hz to 13 MHz in 5 standard and 2 optional ranges. 30% overrange on all ranges.

FREQUENCY RESOLUTION:

Range	Vernier Out (local or remote)	Vernier In (local)	Vernier In* (remote)
10 MHz	10 kHz	10 Hz	1 kHz
1000 kHz	1 kHz	1 Hz	100 Hz
100 kHz	100 Hz	0.1 Hz	10 Hz
10 kHz	10 Hz	0.01 Hz	1 Hz
1000 Hz	1 Hz	1 mHz	0.1 Hz
100 Hz (opt.)	0.1 Hz	0.1 mHz	0.01 Hz
10 Hz (opt.)	0.01 Hz	0.01 mHz	0.001 Hz

*Only first digit of vernier is programmable.

FREQUENCY ACCURACY:

Vernier Out: $\pm 0.001\%$ of setting for 6 mo, 0°C to 55°C.

Vernier In: $\pm 0.01\%$ of range for 6 mo, 0°C to 55°C.

FREQUENCY STABILITY:

Long Term (Vernier Out): ± 10 parts in 10^6 of setting per year.

Signal-to-phase Noise (integrated): > 40 dB down in 30 kHz band, excluding ± 1 Hz, centered on carrier (10 MHz range, Vernier Out). > 60 dB down on 1 MHz range.

Phase Locking: May be phase locked to external frequency of 1, 2, 2.5, 5, or 10 MHz.

HARMONIC DISTORTION: With output frequencies $> 0.1\%$ of range at full amplitude, any harmonically related signal will be less than the following:

- 60 dB with output from 5 Hz to 100 kHz;
- 50 dB with output from 100 kHz to 1 MHz;
- 40 dB with output from 1 MHz to 13 MHz.

SPURIOUS: > 60 dB down, below selected output level or less than -110 dBm, whichever is greater.

REAR-PANEL OUTPUT: Either front or rear panel output, easily changed by routing internal cable.

AUXILIARY OUTPUTS:

Tracking Output: 20-to-33 MHz signal tracks main output with 20-MHz offset. > 100 mV rms/50 Ω .

1-MHz Reference Output: Sine wave, > 220 mV rms/50 Ω .

Low-level Output: Same frequency as main output but remains between 50 and 158 mV rms (into 50 Ω).

3320B Amplitude Section

AMPLITUDE RANGE: +26.99 dBm (5 V rms or $\frac{1}{2}$ watt) to -69.99 dBm (-73.00 dBm under remote control) into 50 Ω .

AMPLITUDE RESOLUTION: 0.01 dB.

FREQUENCY RESPONSE (10 kHz reference):

Leveling Off	Leveling On	
	10 Hz	13 MHz
± 0.5 dB	± 0.05 dB	+26.99 dBm
	± 0.1 dB	-3.00 dBm
	± 0.2 dB	-23.00 dBm
	± 0.4 dB	-73.00 dBm

AMPLITUDE ACCURACY (absolute): ± 0.05 dB at 10 kHz and +26.99 dBm (20°C to 30°C).

ATTENUATOR ACCURACY (at 10 kHz): ± 0.02 dB for each 10-dB step down from +26.99 dBm.

OUTPUT IMPEDANCE: 50 Ω (75 Ω available).

3320A Amplitude Section

AMPLITUDE: Maximum 2 V rms $\pm 10\%$ open circuit
Maximum 1 V rms $\pm 10\%$ into 50 Ω .

AMPLITUDE RANGE: 0 dBm to +13 dBm range through $\frac{3}{4}$ turn front-panel control (not programmable).

FREQUENCY RESPONSE: ± 2 dB over total range.

OUTPUT IMPEDANCE: 50 Ω (75 Ω available).

POWER REQUIREMENTS: 115 V or 230 V $\pm 10\%$, 48 Hz to 63 Hz, < 110 W, (400-Hz operation available).

WEIGHT:

3320A: 32 lb (14.4 kg).

3320B: 34 lb (15.4 kg).

DIMENSIONS: 16 $\frac{3}{4}$ in wide x 5 $\frac{1}{4}$ in high x 19 $\frac{3}{8}$ in deep (behind front panel) 426 x 133 x 492 cm.

OPTIONS:

Option 001: 75 Ω Output Impedance.

Option 002: Reference Crystal Oven*.

Long term stability: ± 1 part in 10^6 /day.

± 1 part in 10^7 /mo.

Option 003: Parallel BCD remote control* (3320A only). Digital remote control of frequency only. Most significant digit of Vernier may also be programmed.

Control lines required: 24 plus remote line.

Frequency switching and settling time: for frequencies $\pm 0.01\%$ of range, 15 ms.

Option 004: Parallel BCD Remote Control* (3320B only). Four digits of frequency, frequency range, overrange, Vernier In/Out four digits of amplitude, leveling-loop response times, controlled digitally.

Control lines required: 40 plus remote line.

Frequency switching and settling time: Same as 003.

Amplitude switching and settling time: to within ± 1 dB, 60 ms; to within ± 0.1 dB, 300 ms; to within ± 0.01 dB, 1.5 s.

Option 006: 100-Hz and 10-Hz Ranges*. Programmable if digital remote options are installed.

Option 007: ASCII Remote Control* (3320B only).

Allows bit-parallel, word-serial digital remote control of all functions except last vernier digit and line switch. Requires 10 input lines. Full digital isolation is standard.

Timing: Max of 8 μ s per word required.

Switching and settling times: same as Opt 004.

LOGIC LEVEL REQUIREMENTS (for all digital remote control options):

State	Requirements
"Low" (logical "1")	0 V to 0.4 V (5 mA max.) or contact closure to ground through < 80 ohms.
"High" (logical "0")	+2.4 V to +5 V or removal of contact closure to ground.

PRICES IN THE USA

3320A, \$1900. 3320B, \$2550.

Option 001, 75 Ω output, no charge.

Option 002, crystal oven, \$290.

Option 003 (3320A), BCD remote control, \$300.

Option 004 (3320B), BCD remote control, \$400.

Option 006, 100 Hz/10 Hz ranges, \$200.

Option 007 (3320B), ASCII remote control, \$595.

* Field Installable.

MANUFACTURING DIVISION: LOVELAND DIVISION
815 Fourteenth Street S.W.
Loveland, Colorado 80537

Conclusion

The Models 3320A and 3320B Frequency Synthesizers fulfill the need for low-cost programmable signal sources as well as having all the attributes of high-quality signal sources for the lab bench.

Acknowledgments

Many people contributed to the successful realization of the new Frequency Synthesizers. Steve Venzke contributed the thermopile detector circuits and leveling-loop dynamics, and Jerry Daniels the exponential D/A converter and output mixer. Bill Spaulding was responsible for the output amplifier as well as making contributions to other parts of the instrument. Bob Temple contributed the vernier and reference oscillators. Chuck Platz developed the software driver for interfacing the 3320B with digital computers. Mechanical design was by Bruce



Ronald K. Tuttle

Although Ron Tuttle earned his bachelor's degree in chem engineering, he elected to stick with dry electronics and took his master's in EE (1961), whereupon he joined Hewlett-Packard in Palo Alto (both degrees were earned at the University of California at Berkeley).

Initially, Ron worked on the Model 5260A Microwave Frequency Divider (a phase-locked oscillator) and also contributed to some early efforts on the Model 5100A/5110A Frequency Synthesizer.

Transferring to HP's Loveland Division in 1964, Ron contributed to the 3406A Sampling Voltmeter and the 204A and 209A Oscillators, ultimately becoming a group leader in oscillator development. This was followed by exploratory work in analog computer circuits before going full-circle to phase-locked oscillators and frequency synthesizers as group leader on the 3320A/B project.

With one-half acre of fertile Colorado soil around his home, Ron indulges in amateur horticulture in his off hours, with occasional help from his three youngsters 10, 9, and 4. When the weeds are under control, the gang goes back-packing and fishing.

Cox and Virgil Leenerts, who also designed the power supplies and the output attenuator. Francis Fiedler worked on the range dividers and control logic as well as doing an excellent job of smoothing the instruments' transfer to production.

The author would also like to acknowledge the many helpful suggestions and encouragement provided by Fred Hanson and Dick Moore. 

References

1. Richard Crawford, 'A Low-Frequency Oscillator with Variable-Phase Outputs for Gain-Phase Evaluation,' Hewlett-Packard Journal, July 1965.
2. 'Thermopile Yields Real RMS,' EDN, April 15, 1970.

Party-line Programming

Making it much easier to incorporate these instruments into automatic test systems, three* of the four Synthesizers described in this issue can be controlled externally through a 'party-line' bus.

Each control (except the power switch on all models, and the last digit of the Model 3320B's VERNIER) has a 7-bit ASCII code assigned to it. Instructions for each control are transmitted one at a time on 7 parallel lines. Each instrument, however, responds only to instructions that directly follow an address assigned to it. Thus several instruments—up to fifteen as a matter of fact—may be connected in parallel to the programming lines and each controlled individually by prefacing instructions with the instrument's individual address code. Only seven data lines plus three operation lines are needed to control a whole group of instruments.

This arrangement greatly simplifies the hardware and software needed for automatic control. Only one computer I/O card or one programming device is needed to control several units.

An accessory Marked Card Programmer (Model 3260A) has been designed for easy control of party-line-programmable instruments where full-scale computer control may not be warranted. When used with a Synthesizer, instructions for frequency and amplitude are marked on the cards. The Card Programmer then generates digital outputs corresponding to the marks on the card and transmits them to the Synthesizer for execution, reading a 32-word card in 1.5 seconds. Production personnel, for example, can operate a measurement setup without extensive training simply by feeding cards to the Programmer for each test.

Since party-line programming requires so few lines (up to 15 vs the 40 or so needed for BCD), it becomes economically feasible to isolate the data lines from internal circuits where it may be necessary to break up low-frequency ground loops or where there is a problem with injection of high-frequency spurious signals from a computer. Electrical isolation is standard with the option that equips the Model 3320B for party-line programming and it is available as an option for the Models 3330A/B.

*The Models 3330A and 3330B Automatic Synthesizers and, with the appropriate option, the Model 3320B Frequency Synthesizer.

The Incremental Sweep Generator— Point-by-Point Accuracy with Swept-Frequency Convenience

Putting a calculator in a 0.1 Hz-to-13 MHz Frequency Synthesizer gives the lab bench the speed and convenience of automatic testing. Amplitude sweeping adds a new dimension.

by Charles A. Kingsford-Smith

TECHNICAL PEOPLE well appreciate the time that swept-frequency techniques can save when characterizing the behavior of networks, components and systems in the frequency domain.

Nevertheless, when high precision is needed, as in testing narrowband devices, conventional sweep generators are inappropriate because of their residual FM, which usually amounts to 100 Hz or so. The result of deriving the frequency sweep by analog voltage control of a free-running oscillator, residual FM tends to smear over fine detail in the response curves. To discern this fine detail, the user is forced to fall back on point-by-point measurements at discrete frequencies, using a signal generator to avoid residual FM, and an electronic counter for accuracy.

When the need was critical—and the budget tolerant—there have been occasions when a user would assemble a computer and a frequency synthesizer with the necessary interface hardware, and then write programs that would direct the computer to sweep the synthesizer incrementally. The result was automated point-by-point measurements and though expensive to implement, the time saved very often justified the effort and expense involved.

This situation provided incentive for development of a new instrument: a frequency synthesizer with a built-in digital controller—an 'intelligent' instrument, so to speak. Because of its built-in 'thinking' capability, the controller could accept commands in a form natural to the human user and convert them to the form needed to control synthesizer operation. This would give in one box the accuracy of point-by-point measurements with the speed and convenience of frequency sweeping.

An Automatic Synthesizer

The result of this effort is shown in Fig. 1. This instrument is an Automatic Frequency Synthesizer with a frequency range of dc to 13 MHz.

This new Synthesizer can sweep incrementally—that is to say, it can automatically step point-by-point through a range of frequencies, giving it capabilities unlike any other signal source in its frequency range. One is the capability to preserve fine detail in response curves.

Another characteristic of incremental sweeping is sweep linearity, highly important for many applications like testing the linearity of FM discriminators. What's more, the frequency at each step, following a brief settling period, *has the same accuracy as the instrument's crystal reference*. Sweep parameters can be set up so frequency is read directly from scale markings on the recorder paper or oscilloscope graticule, with accuracy limited not by the Synthesizer, but by the recording or display device. Residual FM is less than 1 Hz rms (in a 2-kHz bandwidth centered on the carrier).

The incremental frequency step can be as small as 0.1 Hz, or as large as 9.999 999 9 MHz. The time per step ranges from 1 ms to 3 s.

Keyboard tuning

Instrument control from the front panel is best understood by considering the four basic operations:

1. **Enter, display, and output a fixed frequency.** Pressing the **FREQ** button alerts the internal controller that the numerical entry to follow will be a new output frequency. As the numbers and decimal point are entered, they appear at the right of the numeric display and shift left as entry proceeds.

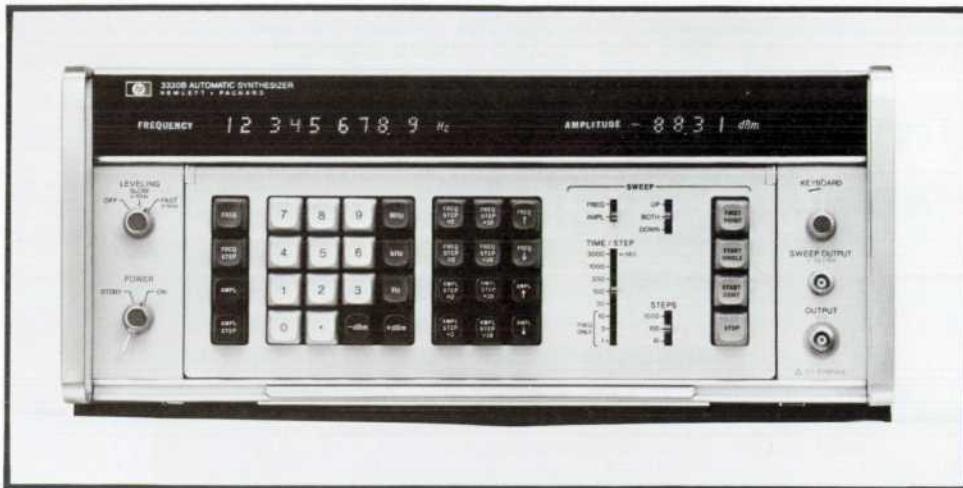

Fig. 1. Model 3330B Automatic Synthesizer is a sweeping frequency standard that allows selection of output frequency with 0.1-Hz resolution in a range of 0.1 Hz to 13 000 999.9 Hz. It also has ac calibrator amplitude accuracy. Built-in digital processor simplifies instrument operation, both by front-panel control or by external programmer.

Entry is complete when one of the frequency unit buttons (MHz, kHz, or Hz) is pressed. The controller then commands the Synthesizer to output the new frequency, and it simultaneously aligns the display to read in Hz, filling in zeros if necessary.

2. **Increment or decrement frequency.** This operation is set up by pressing **FREQ STEP**, followed by the numerical entry and frequency unit, both of which appear on the display. This information is stored in the instrument's memory but the output frequency does not change when the frequency unit is pressed—it waits until either the **FREQ↑** or **FREQ↓** button is pressed. Each time either of these buttons is pressed, the output frequency changes by the amount stored and the display changes to show the new output frequency.

If the **FREQ↑** or **FREQ↓** button is held down, the output frequency and display are repetitively incremented or decremented at a rate determined by the **TIME PER STEP** switch. In this way, the Automatic Synthesizer simulates the manual tuning of a signal generator.

3. **Automatic Sweep.** This is an extension of frequency increment or decrement. When the **START CONT** button is pressed, instead of **FREQ↑** or **FREQ↓**, the output frequency is swept (i.e., stepped) symmetrically about the current value of **FREQ**, which now becomes the center frequency and which remains on the display. Simultaneously, a stepped dc voltage, proportional at any instant to the sweep position, appears at a front-panel output for driving the X-axis of an oscilloscope or X-Y plotter. Slide switches determine the number of steps in the sweep, the time per step, and the sweep direction (up, down, or alternating).

Pressing the **START SINGLE** button generates a single sweep. In this case, the display follows the output to show the instantaneous frequencies, use-

ful when making X-Y plots as it lets the user observe the frequencies where significant events occur.

Additional pushbuttons increase the flexibility of sweep generation. Pressing the **FIRST POINT** button commands the instrument to calculate and display the lowest frequency of the sweep if the sweep slide switch is in the **SWEEP UP** position, or the highest frequency if in the **DOWN** position. Corresponding voltages appear at the **SWEEP OUTPUT** connector. This is convenient for aligning the start and stop positions of an X-Y plotter.

4. **Parameter modification during sweep.** Pressing one of the \times or \div keys during a sweep alters the stored increment at the end of the current sweep. The new value is displayed and subsequent sweep cycles are modified accordingly (the center frequency can be recalled to the display by pressing one of the **FREQ** buttons).

Pressing the **FREQ↑** or **FREQ↓** during a sweep causes the center frequency to be incremented one step at the end of the current sweep. Holding this key down then causes the sweep 'window' to step along the frequency scale, one step per sweep.

Remote Programming

The operations just described can also be initiated by any external device capable of generating TTL logic levels in a sequence of 7-bit words.

Each of the Synthesizer's pushbuttons and switch positions has a 7-bit digital word assigned to it. When any of these words are entered through the rear-panel connector, the Synthesizer responds as it would to the front-panel pushbuttons or switches. External programming is then simply a matter of entering the words in the same sequence as would be done from the front panel.

Programming is greatly simplified by the Synthesizer's built-in 'think' capability. For example, it is

not necessary to individually program each frequency in a frequency sweep; the Synthesizer derives as many as 1000 frequency steps from just five instructions: center frequency, frequency step, number of steps, time per step, and sweep direction.

Each Synthesizer responds only to programming commands that follow a particular 7-bit character, established for that instrument by setting internal switches. Several instruments may thus be connected in parallel to a single set of programming lines (see box, page 8) and controlled by a single programmer or computer I/O card.

Output Characteristics

Actually, the new development involves two instruments, the Models 3330A (Fig. 2) and 3330B (Fig. 1). These instruments are identical in their frequency characteristics, including pushbutton control and incremental sweeping, but differ in their control of output amplitude.

The signal amplitude at the Model 3330A's output ranges from 0 dBm to +13 dBm with a $\frac{3}{4}$ -turn front-panel control. At any setting, the amplitude remains within a respectable ± 0.5 dB across the entire frequency range. The output level is controlled by modulating the amplitude of the 20-MHz reference before the final mixer, as in the Model 3320A described in the article beginning on page 2.

The Model 3330B has the precision level settable of the Model 3320B Frequency Synthesizer (page 6) but it combines this with controller operation. The output amplitude is selected by entering it into the keyboard the same as frequency, a separate numeric display showing the selected amplitude with 4-digit resolution. The output amplitude range is 100 dB, from -86.55 to $+13.44$ dBm/50 Ω (75 Ω optional).

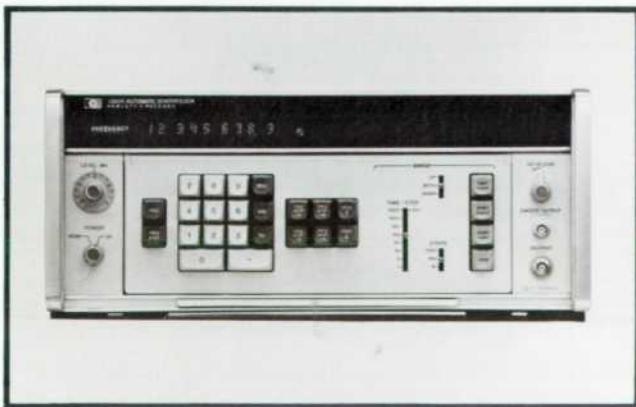

Fig. 2. Model 3330A Automatic Synthesizer provides control of frequency in same way as Model 3330B, but it has one-knob control of output amplitude.

Amplitude Sweeping

An unusual capability is given this instrument by making it possible to enter sweep parameters for amplitude. Thus the amplitude can be swept or stepped the same way as frequency. This mode of operation is useful for automatic plotting of the characteristics of trigger circuits, level discriminators, and overload protection systems.

The instrument cannot sweep amplitude and frequency simultaneously but the amplitude can be stepped at the end of each frequency sweep, making it easy to get families of response curves, as in determining passband changes caused by AGC action.

High-Quality Waveform

The spectral purity of both the Model 3330A and 3330B is of a high order. Harmonic distortion is more than 60 dB below output signals in the 5 Hz-100kHz frequency range, more than 50 dB down at 1 MHz, and more than 40 dB down at 13 MHz. Any nonharmonically related signal will be more than 70 dB below the output, or -110 dBm, whichever is greater. Phase noise (integrated) is more than 50 dB down. A plot of phase noise in a 1-Hz band is shown in Fig. 3.

Modulation

The outputs of both Synthesizers can be amplitude modulated with external signals at rates up to 100 kHz by varying the level of the 20-MHz signal supplied to the output mixer. In the Model 3330B, however, the amplitude control circuit holds the total output power constant so carrier power will decrease when greater depth of modulation increases power in the sidebands.

Inside the 3330A/B Automatic Synthesizers

To make it possible to sweep over a wide frequency range, the Models 3330A and 3330B Automatic Synthesizers use seven interconnected phase-lock loops in a manner similar to the HP Model 8660-series Synthesizers.¹

As shown in the diagram of Fig. 4, each of four phase-lock loops (PLLs), similar to that shown in Fig. 4 on page 4, selects two of the digits for the output frequency. Each summing loop (SL) adds the frequency of the phase-lock loop below it to 1/100 of the frequency coming from its left. The diagram explains how a typical frequency (11.1223344 MHz) is derived.

Several techniques are used to speed up response of the system to programmed changes in frequency. As in the Models 3320A/B, a 'pre-tune' voltage speeds up a frequency change in the phase-lock

loops. Each summing loop also responds to a 'pre-tune' voltage (not shown in Fig. 4) that performs the additional function of preventing the loop from locking up on the image frequency 400–600 kHz away.

For detectors, the phase-lock loops use samplers, similar to those used on sampling oscilloscopes. Because these hold the most recent sample level between samples, filtering requirements are reduced. This means less in-band phase shift and thus better loop dynamics.

The phase detector in the summing loops uses logic to interpret the relative zero crossings of oscillator and reference. When an out-of-lock condition is sensed, it switches the loop to operate as a fast-responding frequency discriminator. Once lock-up is achieved, the system reverts to the phase-lock mode and the remaining phase error settles exponentially to its final value. The time derivative of the phase error is the instantaneous frequency error, the limits of which are described in the specifications of switching speed on page 15.

During frequency changes, all seven loops may contribute to an output frequency transient. The joint transient behavior of phase-lock loop #1 and summing loop #1 translates directly to the output whereas transients from PLL2 and SL2 are reduced by 10^2 , those from PLL3 and S3 by 10^4 , and from PLL4 by 10^6 . Hence, settling time depends upon which digits are switched, as shown in Fig. 5. Phase coherence is maintained in the output signal for frequency steps of less than 10kHz.

Amplitude Control

Although the amplitude control circuit in the 3330B is identical to that in the Model 3320B, the use of digital control adds special capability, in ad-



Fig. 3. Typical single-sideband phase noise measured at output of Model 3330A/B Automatic Synthesizer in 1-Hz bandwidth with instrument operating at 12 MHz.

dition to the sweep capability previously mentioned. The attenuator system works over a range of 0 to 100 dB but the Controller adds a constant to the attenuator setting so the numeric display can read output level directly. The constant is provided by an internal 16-bit BCD switch register which is set at the factory to +13.44 dBm to give readings that range from -86.55 to +13.44 dBm. The constant can easily be changed by the user in the field, however, to any other number by going inside the instrument and resetting the switches. This makes it possible to adjust the readout to give the output level directly when an external amplifier or pad is included in the system (within the constraints of the -99.99 to +99.99 display range).

The nature of transients introduced by amplitude switching depends on whether or not the step attenuator is involved. For example, when stepping from +3.44 to +3.45 dBm during an amplitude sweep, the step attenuator goes from 10 to 0 dB while the leveling-loop's electronic attenuator goes from 0.00 to 9.99 dB. The resulting behavior is shown in Fig. 6.

An open-loop reset signal enables the electronic attenuator to switch to about 20% of final value within a few milliseconds. The remaining part of the transient is governed by the closed-loop time constant and is about 35 ms with the front-panel LEVELING switch set for 'fast,' or about 350 ms in 'slow' (the 'slow' response is provided to permit leveling at output frequencies as low as 10 Hz).

Controller

One of the choices to be made during project definition was whether to use a computer-like organization for the Controller, or to use a dedicated, hard-wired, logical control system. With the recent advances in processor design, including lower cost, greater capability, and more powerful sequential design methods, the computer-like organization was chosen because it meant that routines would be realized as software, i.e. stored programs. Any revisions in the complex operating routines envisioned for the Synthesizer could then be implemented easily.

The principal operating blocks of the Controller, shown in Fig. 7, have these functions:

Input/Output. Each key and switch position is assigned a 7-bit ASCII code. These are loaded into the input register in bit-parallel, character-serial format from either the front-panel controls or the rear-panel connector (grounding a line on this connector automatically switches the Synthesizer to respond to remote commands).

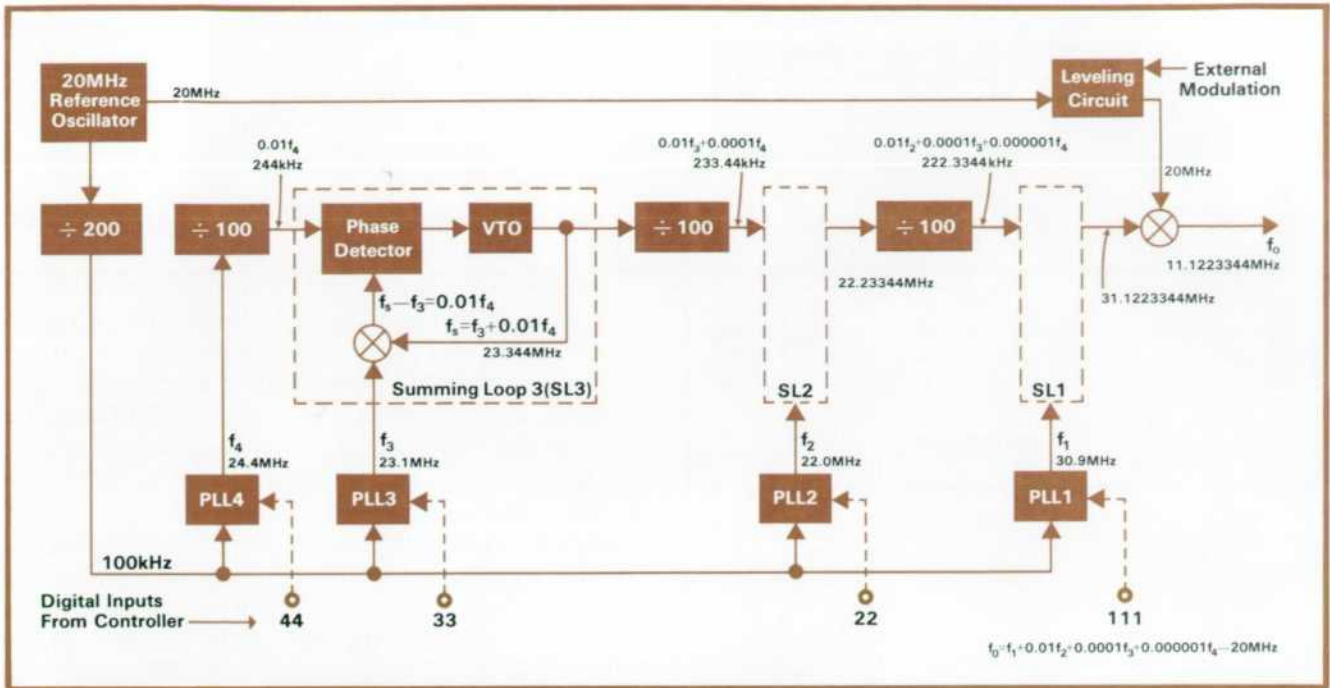

Fig. 4. Simplified block diagram of Automatic Synthesizer frequency generating circuits.

The single output register is loaded in BCD-parallel format and its output is time-division multiplexed to the frequency-generating circuits, to the amplitude control (Model 3330B), to the front-panel numeric indicators, and to the D-A converter that provides the analog SWEEP output.

Read-write memory. Data entered by the operator is stored here along with data that changes during operation. For example, during a sweep, the Controller outputs data for one point, then immediately calculates and stores the next point in the memory while waiting for the step-interval timer.

Arithmetic logic unit. This is a read-only memory (ROM) that performs certain logical operations on

its inputs (add/subtract/and/or, etc.). The close resemblance to minicomputer architecture is apparent here, except that the operation is bit-serial to achieve compactness and low cost.

Control. As the 'heart' of the Controller, this section contains the permanent instructions and data required for the many instrument operating routines. It is a 256×48 ROM combined with eight state-storage flip-flops.

Auxiliary registers. Several 1-, 4-, 8-, and 16-bit registers complete the structure.

A brief overview of how the Controller handles a particular routine may be helpful. Fig. 8 is a flow chart of a part of the sweep algorithm called 'pa-

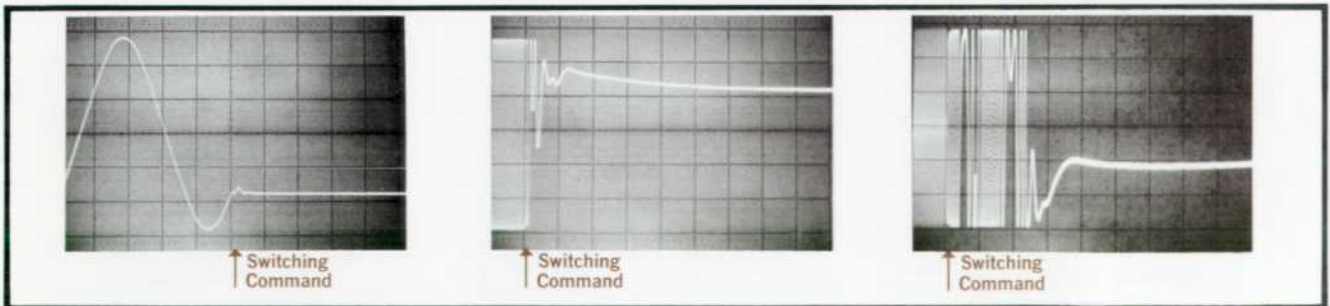

Fig. 5(a). Photo above shows small transient as Synthesizer switches from 10.000 99 MHz to 10.000 00 MHz, a full-range transition for PLL3 (10 MHz has been subtracted from Synthesizer output to clarify presentation).

(b). Switch from 10.099 MHz to 10.000 MHz, a full range transition for PLL2, has transient that lasts for well under one millisecond. (Sweep speed in all photos is 0.2 ms/cm.)

(c). Switch from 100.005 kHz to 12.999 999 5 MHz represents worst case transient involving near maximum transition for all loops. (In this case, 12.999 999 5 MHz was subtracted from output.)

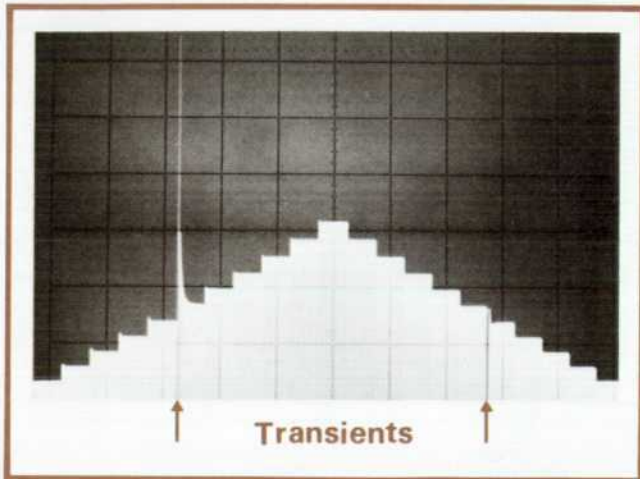

Fig. 6. Photo shows 10-step amplitude sweep centered at 3.45 dBm, where 10-dB step attenuator switches and introduces amplitude transients. Amplitude steps are 0.2 dB of 100 ms each. (Oscilloscope sweep speed: 200 ms/cm.)

parameter modify.'

Let us assume that the operator presses the AMPL STEP $\div 2$ key during an amplitude sweep. As in any sweep, the Controller checks the input register after each step to see whether or not a key has been pressed. If so, it deciphers what class of key was pressed to determine appropriate action. Numeric keys, for example would be ignored in this case but a parameter-modify key, such as AMPL STEP $\div 2$,

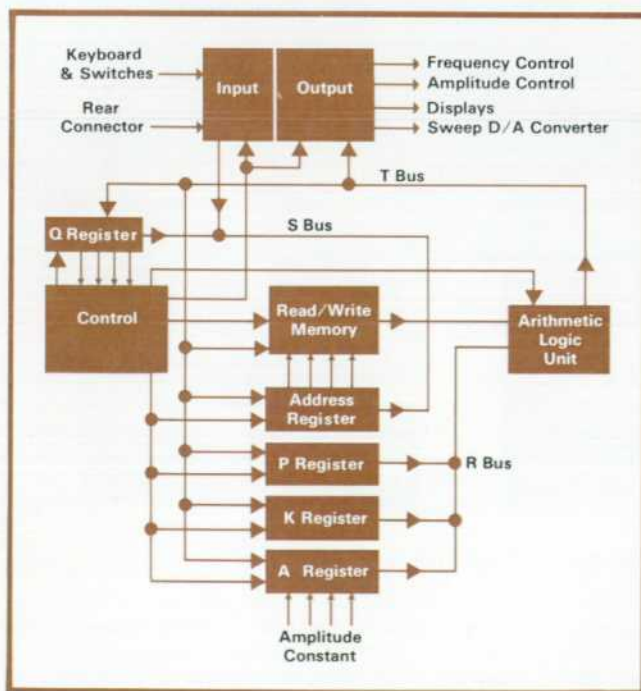

Fig. 7. Principal operation blocks of digital controller.

causes additional action to be taken at the end of the current sweep. In this case, the Controller branches to the routine shown in Fig. 8, modifying succeeding sweep cycles accordingly.

Acknowledgments

Because of the wide range of technical disciplines involved in design of the 3330A/B Automatic Synthesizers, the project was organized around three principal responsibilities. The leaders were Cullen Darnell, for frequency synthesis and amplitude processing, Clair Nelson for the digital processor, display, and keyboard, and Richard Huffman for mechanical design and project coordination. Contributing to the overall effort were Jerry Weibel, power supplies and some digital design, William Nicolay, who had overall responsibility for the Model 3330A and who is presently shepherding both instruments through initial production, Roger Cox who helped with the digital memory, Jerry Nichol, involved with mechanical design, and Bob Temple who designed the reference oscillator.

References:

1. J. C. Shanahan, 'Uniting Signal Generation and Signal Synthesis,' Hewlett-Packard Journal, Dec. 1971.

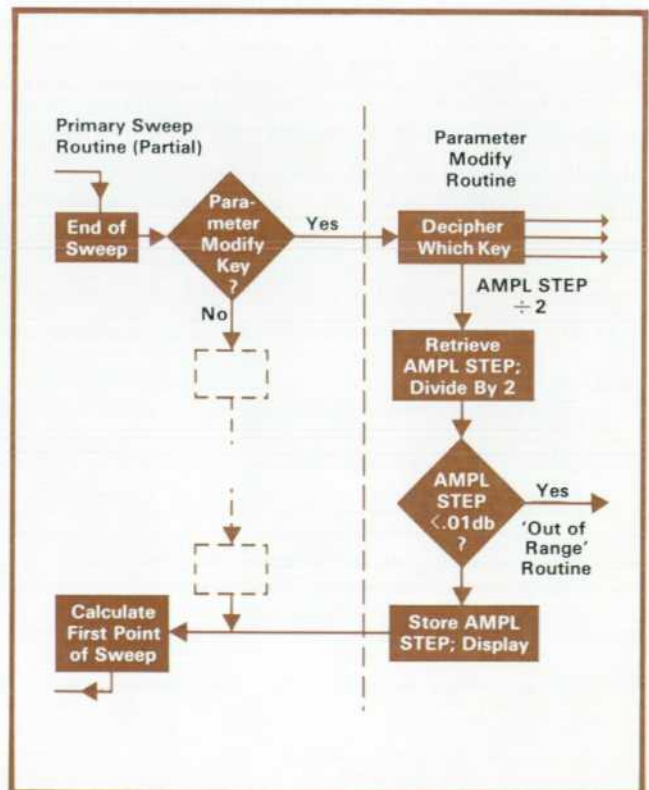

Fig. 8. Flow-chart of part of sweep algorithm called 'parameter-modify.'



Charles Kingsford-Smith

Though born in Australia, Chuck Kingsford-Smith was educated in the U.S., earning his BSEE at Louisiana State University (1954) and his MSEE at the University of California at Berkeley (1966). Before joining HP in 1965, Chuck did some design work on color TV and also spent two years teaching EE in Brazil.

At HP, Chuck worked on the Model 5105A 500-MHz Frequency Synthesizer in Palo Alto. He transferred to the Loveland (Colorado) Division in 1966 where he developed the Model 676A Tracking Detector (HP Journal, July 1969) before becoming group leader on the Models 3330A/B Automatic Synthesizers. Chuck holds seven patents.

One of four members of a club that owns an airplane, Chuck enjoys private flying and the associated avionics. He also enjoys fly-fishing, classical music, reading, and his wife's gourmet cooking.

SPECIFICATIONS HP Model 3330A/B Automatic Synthesizer

FREQUENCY RANGE: 0.1 Hz to 13,000,999.9 Hz.
FREQUENCY RESOLUTION: 0.1 Hz (8 digits + overrange).
FREQUENCY STABILITY:
LONG TERM: $\pm 1 \times 10^{-8}$ per day,
 $\pm 1 \times 10^{-7}$ per month.
TEMPERATURE: $\pm 1 \times 10^{-9}$ 25°C $\pm 5^\circ\text{C}$,
 $\pm 1 \times 10^{-7}$ 0°C to 55°C.
SIGNAL-TO-PHASE NOISE (integrated): > 50 dB down in 30 kHz band, excluding ± 1 Hz, centered on carrier.
EXTERNAL FREQUENCY REFERENCE: May be phase locked to signal that is a subharmonic of 20 MHz.
HARMONIC DISTORTION: With full output amplitude any harmonically related signal will be less than the following specified levels:
-60 dB with output from 5 Hz to 100 kHz.
-50 dB with output from 100 kHz to 1 MHz.
-40 dB with output from 1 MHz to 13 MHz.
SPURIOUS:
3330A: All nonharmonically related spurious signals will be greater than 70 dB below selected output level.
3330B: All nonharmonically related spurious signals will be greater than 70 dB below selected output level or less than -110 dBm/50 Ω whichever is greater.

FREQUENCY SWITCHING AND SETTLE TIME:

Largest digit changed	0.1 Hz or 1 Hz	10 Hz or 100 Hz	1 kHz or 10 kHz	100 kHz, 1 MHz or 10 MHz
Switching and Settling Time	<1 ms to within 500 μHz	<1 ms to within 0.05 Hz	<1 ms to within 5 Hz; <50 ms to within 0.01 Hz	<1 ms to within 500 Hz; <50 ms to within 1 Hz

REAR PANEL OUTPUT: Output through front or rear panel by rerouting internal cable.

AUXILIARY OUTPUTS:

20-33 MHz tracking output that is always 20 MHz above output, > 100 mV rms/50 Ω .
1 MHz reference output, > 220 mV (> 0 dBm)/50 Ω .

SWEEP OUTPUT: Stepped dc voltage proportional to sweep position, 0 to +10 V.
LINEARITY: $\pm 0.1\%$ of full scale.

DIGITAL OUTPUTS:

STEP COUNT: 0 to 1000 count on 12 BCD (1-2-4-8) lines to indicate sweep position.
SWEEP STATUS: Indicates when instrument is sweeping. (Useful as plotter pen lift control.)
STEP READY: Indicates instrument is ready to go to next step.

3330A AMPLITUDE SECTION:

AMPLITUDE: Max 2 V rms $\pm 10\%$ open circuit. Max 1 V rms $\pm 10\%$ into 50 Ω .
AMPLITUDE RANGE: 0 to +13 dBm through $\frac{1}{4}$ turn front panel control (not programmable).

FREQUENCY RESPONSE (10 kHz reference): ± 0.5 dB across total range.

OUTPUT IMPEDANCE: 50 Ω .

AMPLITUDE MODULATION: Requires external modulation source.
MODULATING SIGNAL: dc to 100 kHz.
MODULATION DEPTH: 0.95 V rms modulating signal for 95% modulation depth. (0.01 V rms/1% depth.) Output level setting must be at least 5 dB below max to avoid peak compression.

3330B AMPLITUDE SECTION:

AMPLITUDE: Max 2.1 V rms into open circuit. Max 1.05 V rms into 50 Ω .
AMPLITUDE RANGE: +13.44 dBm to -86.55 dBm into 50 Ω .
AMPLITUDE RESOLUTION: 0.01 dB.

OUTPUT IMPEDANCE: 50 Ω .

DISPLAY: Four-digit readout in dBm with reference to 50 Ω . (Internally adjustable by user to compensate for external attenuation or amplification.)

LEVELED FREQUENCY RESPONSE (10 kHz reference):

10 Hz	(SLOW)	1 kHz	(FAST)	13 MHz
		± 0.05 dB		+13.44 dBm
		± 0.1 dB		-16.55 dBm
		± 0.25 dB		-36.55 dBm
		± 0.5 dB		-66.55 dBm
		± 0.5 dB		-86.55 dBm

UNLEVELED FREQUENCY RESPONSE (LEVELING "OFF"):

± 0.5 dB over entire range.

AMPLITUDE ACCURACY (absolute): ± 0.05 dB at 10 kHz and +13.44 dBm (25°C).

ATTENUATOR ACCURACY: ± 0.02 dB for each 10-dB step down from maximum output (25°C $\pm 5^\circ\text{C}$).

AMPLITUDE MODULATION: Requires external modulation source. ALC switch must be in SLOW position.
MODULATING SIGNAL: 100 Hz to 100 kHz.
MODULATION DEPTH: Same as 3330A.

DIGITAL REMOTE CONTROL:

TIMING: Max of 310 μs per digit to enter digits of frequency or amplitude (3330B only).
Max of 1 ms to enter and initiate program control codes.
Max of 2.5 ms to enter and initiate sweep (single or continuous) or calculate FIRST POINT.

INPUT CONTROL LINES: 7 "Program Data" lines
1 "Data Valid" line
1 "Remote Enable" line
1 "Response Enable" line
1 "Step Inhibit" line (use not required)

OUTPUT CONTROL LINES: 1 "Data Accepted" line (use not required)
14 "Sweep Parameter" lines (use not required)

LOGIC LEVEL REQUIREMENTS:

State	Requirements
"Low" (logical "1")	0 V to 0.4 V (5 mA max) or contact closure to ground through < 80 ohms.
"High" (logical "0")	+2.4 V to +5 V or removal of contact closure to ground.

GENERAL:

OPERATING TEMPERATURE: 0°C to +55°C.

TURN-ON TIME:

Application of power to instrument: < 20 min to within 1×10^{-7} of final frequency.

"Standby" to "On": < 15 s to full specifications.

POWER REQUIREMENTS: 115 V or 230 V $\pm 10\%$, 48 Hz to 63 Hz, (400-Hz line frequency operation available), < 20 W standby, < 200 W on.

WEIGHT:

3330A: 49 lb (22.1 kg).

3330B: 50 lb (22.6 kg).

DIMENSIONS: 16 $\frac{1}{2}$ in wide x 7 in high x 21 $\frac{1}{2}$ in deep (436 x 178 x 547 mm).

OPTIONS:

OPTION 001: 75 Ohm/1 V rms Output Power Amplifier Attenuation and output referenced to 75 Ω .

AMPLITUDE RANGE:

3330A: +11 dBm to -2 dBm.

3330B: +11.25 dBm to -88.74 dBm.

OPTION 002*: High Stability Crystal Oven

FREQUENCY STABILITY:

Long term: $\pm 1 \times 10^{-8}$ per day, $\pm 2 \times 10^{-8}$ per month.
Temperature: $\pm 1 \times 10^{-9}$ 25°C $\pm 1 \times 10^{-7}$ 0 to +55°C.

OPTION 003: Deletion of Crystal Oven.

Ambient-temperature crystal reference oscillator. Recommended for applications where only moderate frequency stability is needed or where external reference is used. (Standard Crystal Oven can be installed later.)

FREQUENCY STABILITY: ± 10 parts in 10^6 /yr.

OPTION 004: Isolated Digital Input.

With this option, digital input lines are electrically isolated from signal ground.

DC ISOLATION: ± 250 V.

AC ISOLATION: > 30 dB, 0 to 1 MHz.

OPTION 005*: 5 V rms/50 Ohm Output Power Amplifier. This gives 3330A/B $\frac{1}{2}$ -watt output (5 volts rms into 50 ohms or 10 volts rms into open circuit).

AMPLITUDE RANGE:

3330A: 27 dBm to 14 dBm into 50 ohms.

3330B: +26.99 dBm to -73 dBm into 50 ohms.

PRICES: (Domestic USA Prices Only)

3330A, \$3100.

3330B, \$6000.

Option 001, 75 Ω /1 V Output, no charge.

Option 002, High-stability Crystal, add \$500.

Option 003, Deletion of Crystal Oven, less \$200.

Option 004, Isolated digital inputs, add \$225.

Option 005, 5 V/50 Ω Output, add \$250.

*Field Installable.

MANUFACTURING DIVISION: LOVELAND DIVISION
815 Fourteenth Street, S.W.
Loveland, Colorado 80537

Microprogramming and Writable Control Store

Here's what these powerful but little-understood features of the HP 2100A minicomputer mean to the user.

By Fred F. Coury

WRITABLE CONTROL STORE (WCS), or user-programmable control memory, is now available as an option for the Hewlett-Packard 2100A Computer (see Fig. 1). It represents a significant step forward in minicomputer technology. However, many users do not fully understand what it is, what it does, and most important, what it means to them.

To understand WCS and its implications, it's

necessary to understand *microprogramming*, another concept that is often not fully understood and therefore not used to its full potential. The concept of microprogramming was first presented by M. V. Wilkes in 1951 as a method of simplifying the design and implementation of complex instruction sets in digital computers.

The block diagram of a digital computer is shown in Fig. 2. Generally speaking, the lower three blocks

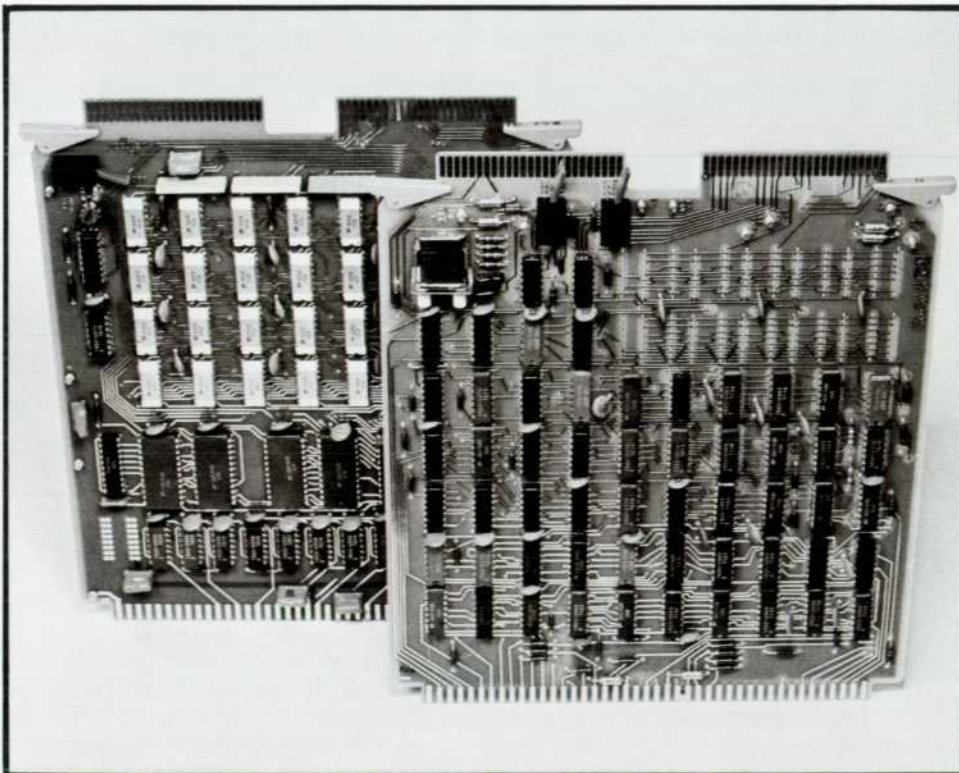

Fig. 1. Installed in I/O slots of 2100A Computer, Writable Control Store (left) simplifies debugging of microprograms to extend computer's instruction set. Microprograms are then committed to read-only memories and installed in empty spaces on microprocessor board (right). WCS also has uses in systems and in education.

(program and data store, arithmetic/logic unit, and input/output section) are rather straightforward, regular in structure, and quite similar in most computers. The sequence of operations to be performed by the computer is determined by the user's program, which resides in the program and data store. The control section reads the user's software instructions and directs the appropriate hardware to execute each instruction.

The logic of the conventional control section, unlike that of the other blocks in Fig. 2, is usually random in nature, with specific hardware dedicated to each function a particular computer is to perform. This usually means a unique design for each different computer and changes and/or additions to the hardware to implement changes and/or additions to existing capabilities.

In a microprogrammed computer, the structure of the control unit is made regular by separating the functions to be performed by the control unit from the sequence in which the functions are to be performed. The functions are specified by control lines which go to various points in the memory control, arithmetic/logic unit, and I/O section, as in the classical implementation. However, the sequencing of control functions is defined by a sequence of bit patterns, or *microinstructions*, from the *control store* which is now part of the control section (see Fig. 3). The sequence of microinstructions is called a *microprogram* and is often referred to as *firmware* because it lies somewhere between hardware and software in origination and permanence.

Conceptually, microprogramming offers real advantages to the computer designer because it allows him to simplify and regularize his design and to implement complex instructions by means of complex sequences of microinstructions, rather than by means of complex hardware.

Implications for the User

This is all fine, if you happen to be a computer designer. But if you are a computer user, then what does microprogramming mean to you?

First, it means higher performance at lower cost. The extended arithmetic instructions (integer multiply, divide, etc.) are standard features of the 2100A because they require no additional hardware, just some additional microinstructions in the same control store area as the standard instruction set.

Second, it means higher speed. This is a function of two things: one, the ratio of the speed of the control store to the program store, and two, the relative power of the microinstructions versus the

user instructions. In the 2100A the control store, where microinstructions reside, cycles five times as fast as the program store, where software instructions reside. Also, the microinstructions are 24-bit words versus 16 bits for the software instructions, and the microcode has access to several scratch-pad registers that the software can't use. As a result, the 2100A floating-point instructions, for example, run about twenty times faster than the corresponding software subroutines.

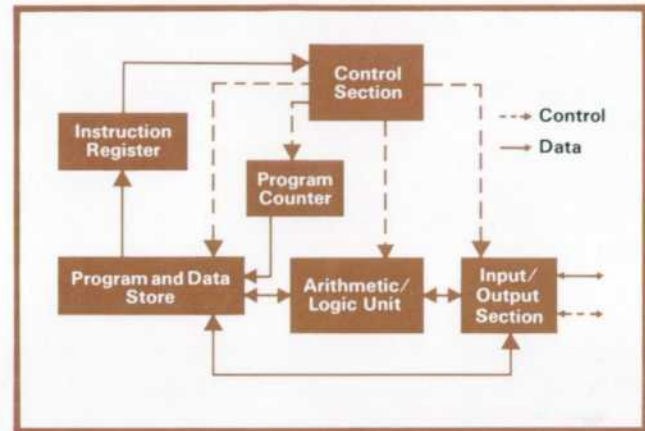

Fig. 2. Generalized block diagram of a digital computer.

Programs Run Faster

What does this mean in terms of applications? Network optimization programs take a long time to run—hours with floating-point software subroutines. One in-house microwave network optimization program was spending about ninety percent of its time in floating-point subroutines (see Fig. 4). Substitution of floating-point firmware sped up the floating-point instructions by a factor of almost twenty and reduced overall program execution time by a factor of five! In fact, a factor of five reduction in the overall execution time of a compute-bound program is quite common when the software code which is limiting performance is written into firmware. Consider the alternative method of increasing overall speed by a factor of five, that is, to speed up the whole machine by a factor of five. Then consider the cost of implementing a 200-nanosecond computer versus microprogramming a one-microsecond machine like the 2100A, and the advantages of microprogramming are clear.

Add New Instructions

This brings us to the third advantage of microprogramming: instruction set flexibility. Since the user instruction set is defined by firmware routines,

new instructions can usually be added merely by extending the microcode.

It should be noted here that there are two extremes to instruction set flexibility. On the one hand there are non-microprogrammed machines. Their instruction set is fixed and any additional instructions require additional hardware. On the other hand, there are general purpose emulators—machines which can be made to emulate any other machine, but which have no identity of their own.

It should also be noted that supportability is inversely proportional to flexibility; that is, the more undefined a computer is, the harder it is to support with software and peripherals. HP has tried to realize the best of both worlds in the 2100A by providing a fully supported instruction set plus the capability to extend that instruction set in firmware.

Again, what does this really mean to the user? How does he actually go about adding new instructions tailored to his particular application? And, in view of the fact that the probability of having a program run perfectly the first time is exponentially approaching zero, how does he debug his microprogram?

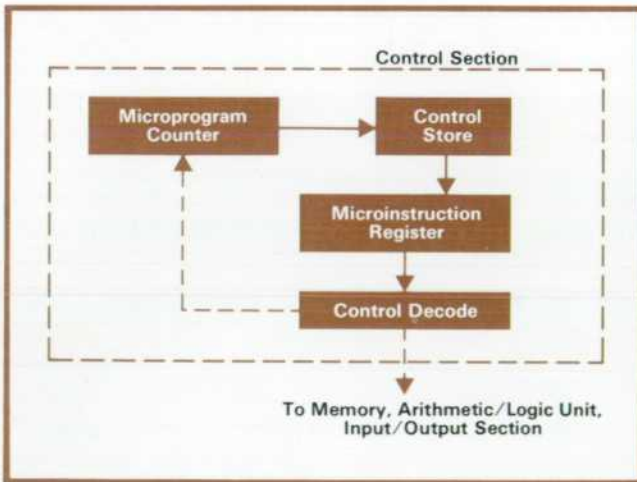

Fig. 3. Microprogrammed control section has its own instruction set and its own memory (control store), which is typically much faster than the main computer memory (program and data store).

That's where writable control store comes in. Although Fig. 3 shows the control store as being a read-only memory (ROM), the program had to be written into it somehow. In more classical implementations this was done by hand or by machine (e.g., diode matrices, braided cores, or masked integrated-circuit ROMs).

However, there is nothing to prevent data from being written into the control store automatically

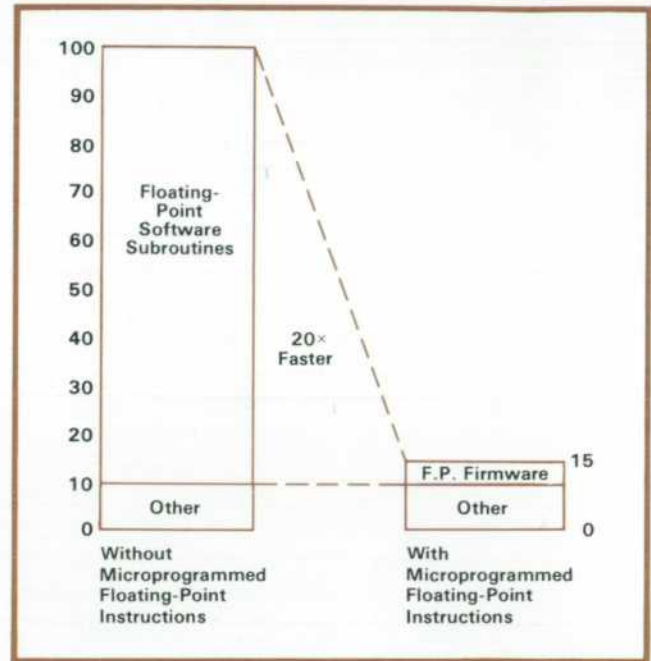

Fig. 4. Execution speed of an in-house microwave network optimization program was improved by a factor of more than five by implementing floating-point subroutines in firmware.

by the computer which it controls (assuming the computer instruction set is already well enough defined to support such an operation). This is exactly what WCS is in the 2100A (see Fig. 5). To the 2100A computer, WCS looks like an output device, that is, the computer sends data to it. To the control unit, however, WCS is indistinguishable from the basic instruction set microprograms (implemented in masked IC ROMs) or the floating-point microprograms.

To the user, this means that for the first time he can easily and efficiently use a fully-supported general-purpose computer to aid in the generation

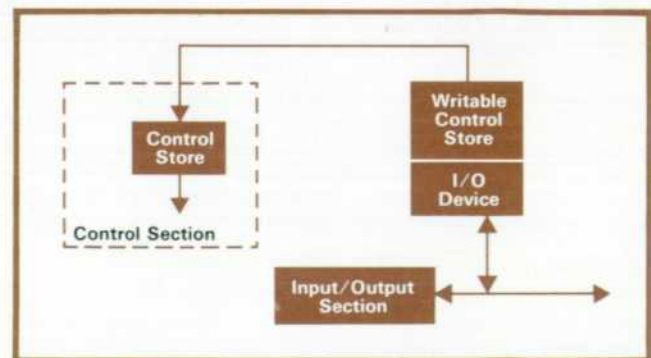

Fig. 5. Writable control store looks like an input/output device to the 2100A computer, and as an extension of the control store to the control section of the 2100A.

and debugging of extensions to its own instruction set, on-line and in real time.

It is important to note also that WCS physically fits into existing I/O slots in the 2100A's mainframe, and microinstructions in WCS run as fast as those in ROM. This means that new microprograms can be tested and debugged in the actual application for which they are written. If it works in WCS you know it will work in ROM.

Once the new microinstructions have been debugged, they can be implemented in read-only memories and installed in the empty spaces provided on the two microprocessor boards in the 2100A. The WCS boards can then be removed, freeing the I/O slots for normal use.

From WCS to ROM

This brings up the question of support, first in writing microprograms for the 2100A, then in loading and debugging programs in WCS, and finally in converting these programs to ROMs after they have been tested in WCS. The support package for WCS (see Fig. 6) includes a microprogramming manual, a microassembler, a WCS editor, a WCS driver, and a mask generator to provide tapes for subsequent ROM implementation. All of this software runs on a standard 2100A computer, a good example of the 2100A's balance between supportability and flexibility.

Another 2100A option is the HP 12909A Programmable-ROM Writer. This is another I/O card which writes the bit patterns specified by the mask tapes into field-programmable ROMs which can then be permanently installed in the computer.

The most significant contribution of WCS may be that it lowers the threshold for a user to consider adding custom instructions to his 2100A. For a modest investment in terms of equipment and programming time, he can tailor the 2100A to his own specific application. Indeed, in some applications, WCS and the programmable-ROM writer can be cost-justified on the basis of the increased system performance brought about by the implementation of a single instruction (for example, replacing an inner loop or an often-used subroutine) in one system. Thus WCS brings the benefits of microprogramming out of the computer design laboratory and into the user's own area.

Applications

There are three principal applications of WCS. The first, as outlined above, is as a vehicle to test and debug microprograms before they are com-

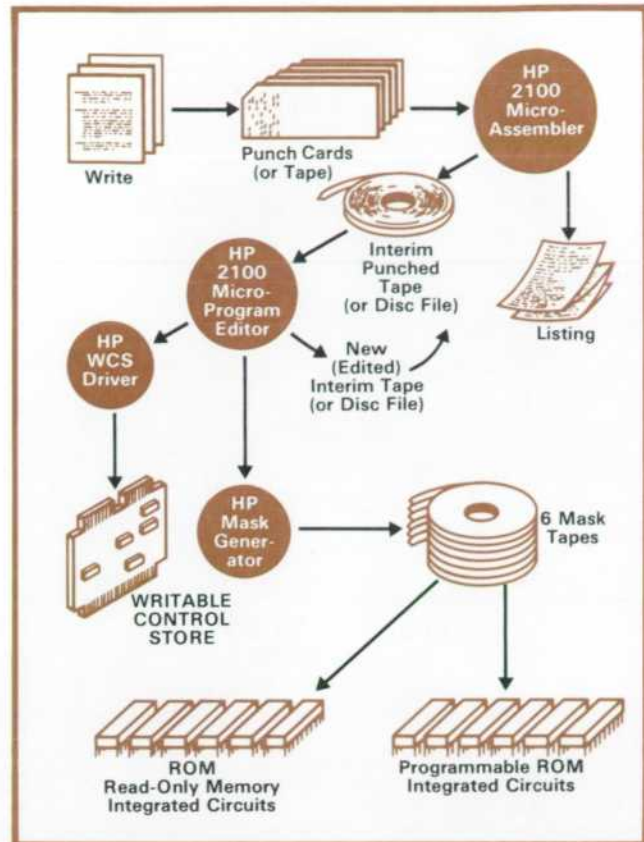

Fig. 6. The writable control store package for the HP 2100A Computer includes a microprogramming manual, a microassembler, a WCS editor, a WCS driver, WCS hardware, and a mask generator which produces tapes to be used in manufacturing read-only memories.

mitted to more permanent storage media.

The second application is in systems which dynamically alter the computer's instruction set to optimize the tasks they are called on to perform. For example, a disc operating system might load a compiler into the program store, then load a set of compiler-oriented 'macros' (microprogram-defined instructions) into the control store. This allows the compiler to execute very efficiently. When the resulting object program is loaded into the program store for execution, the control store is reloaded with a set of, say, scientific macros to speed execution of a mathematical program, or a set of decimal macros for a business program. Then, when a compilation is requested again the compiler and its associated macros are reloaded.

The third applications area is in education, particularly in computer systems design. HP's WCS has a switch which allows the 2100A's basic instruction set to be entirely replaced by a user-defined set. This allows actual hands-on instruction set design experience in the classroom.

Here again, the flexibility/supportability balance comes into play. Suppose a classroom is equipped with a 2100A with WCS, 8k of core memory, a teleprinter, a photoreader, and a high-speed punch. The students use this system to microprogram a totally different machine. They then use the 2100A system to load their microprogram into WCS, and when they throw the switch, *voilà!*, they have a completely different computer. But this completely new machine already has 8k of memory, a teleprinter, a photoreader, and a high-speed punch. It may even have WCS! If a bug is detected in the microprogram, the switch can be thrown back to its original position, and the 2100A system is ready to aid in updating the microprogram. From full support to total flexibility and back again at the flip of a switch!

SPECIFICATIONS
HP Model 12908A
Writable Control Store

CAPACITY

WORDS AVAILABLE: 256 per module.
 MAXIMUM WCS MODULES: 3 per 2100A.
 WORD SIZE: 24 bits.
 MAXIMUM PRIMARY ENTRY ADDRESSES: 16.

MICROINSTRUCTION TIME:

196 microseconds.

INSTALLATION

One to three plug-in boards located in Input/Output slots A10, A11 or A12. Writable control store may be used as any module. Module 1, 2 or 3 is normally used. Module 0 is available but not recommended by Hewlett-Packard. (Module 0 contains the basic 2100 instruction set.)

DATA STORAGE

Input/Output Group instructions or via a 2100 Direct Memory Access channel (if present).

DATA READBACK

Input/Output Group instructions only.

INTERFACE CURRENT SUPPLIED BY COMPUTER

0.15A (-2V supply); 4.6A (+4.85V supply).

PRICES IN U.S.A.

HP 12908A Writable Control Store:
 printed circuit assembly consisting of Writable Control Store card, cable assembly, Writable Control Store software and documentation, \$3500.
 HP 12908A-001 Writable Control Store card, \$2250.
 HP 12909A programmable ROM Writer for use with 2100A/12908A Systems, \$500.

MANUFACTURING DIVISION: DATA PRODUCTS GROUP
 11000 Wolfe Road
 Cupertino, California 95014

Acknowledgments

It was Chuck Leis' sophisticated insight into microprogramming that led to his proposal of WCS as implemented in the 2100A. Don Jenkins actually designed the board and made it work. 📷

References

1. M. V. Wilkes, Report of Manchester University Computer Inaugural Conference, July 1951 (Manchester, 1956).
2. HP 2100A Computer Microprogramming Guide.
3. C. T. Leis, 'Microprogramming, ROMs, Firmware and All That,' Hewlett-Packard Journal, Oct. 1971.
4. S. S. Husson, 'Microprogramming Principles and Practices,' Prentice-Hall, 1970.



Fred F. Coury

Fred Coury is minicomputer section manager with the HP Data Products Group. He came to HP in 1969 after several years of research and teaching, and led the team that developed the 2100A Computer. A graduate of the University of Michigan, Fred received his BS degree in science engineering in 1963 and his MS degree in systems engineering in 1967. He has written and taught extensively in the fields of minicomputer design and applications, digital systems design, digital laboratory equipment, and computer applications, and is the author of 'A Practical Guide to Minicomputer Applications' (IEEE Press). He's also a member of the COSINE Task Force on Digital Laboratories. Aside from computers, Fred's interests run to woodcrafts, bow-hunting, judo, and keeping his 1934 Ford pickup running.

Technical Information from the Laboratories of Hewlett-Packard Company, 1501 Page Mill Road, Palo Alto, California 94304 U.S.A.
 Hewlett-Packard S.A., 1217 Meyrin—Geneva, Switzerland
 Yokagawa-Hewlett-Packard Ltd., Shibuya-Ku, Tokyo 151 Japan



Editorial Director: Howard L. Roberts
 Managing Editor: Richard P. Dolan
 Contributing Editors: Ross H. Snyder, Laurence D. Shergalis
 Art Director, Photographer: Arvid A. Danielson
 Art Assistant: Erica R. Helstrom
 Administrative Services: Ruth G. Palmer

HEWLETT-PACKARD JOURNAL
 JULY 1972 Volume 23 • Number 11